

ART NO	A	B	C	NW
	inch	mm	mm	g
5079Z-10	3/8"	53	7	10
5079Z-12	1/2"	55	7	12

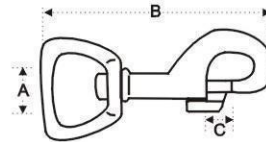

ART NO	A	B	C	NW
	inch	mm	mm	g
5079ZT-10	3/8"	54	7	10
5079ZT-12	1/2"	54	7	11

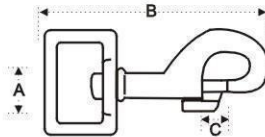

ART NO	A	B	C	NW
	inch	mm	mm	g
0148Z-12	1/2"	54	7	11
0148Z-19	3/4"	54	7	13
0148Z-25	1"	54	7	14

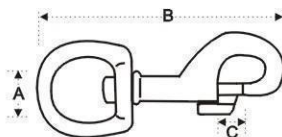

ART NO	A	B	C	NW
	inch	mm	mm	g
5055Z-10	3/8"	63	9	18
5055Z-12	1/2"	65	9	18.5
5055Z-16	5/8"	68	9	19
5055Z-19	3/4"	70	9	19.5
5055ZN-12	1/2"	60	9	18

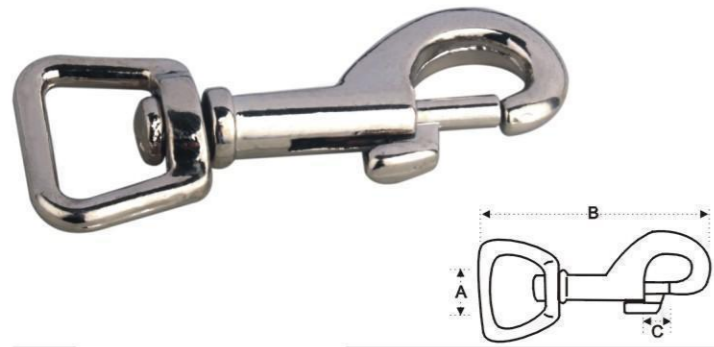

ART NO	A	B	C	NW
	inch	mm	mm	g
5055ZT-16	5/8"	63	9	19
5055ZT-19	3/4"	63	9	20
5055ZT-25	1"	63	9	21

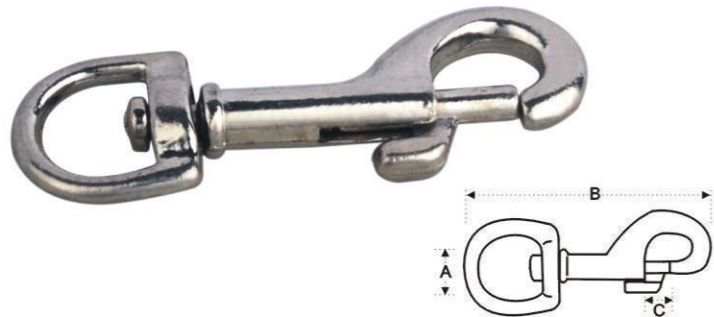

ART NO	A	B	C	NW
	inch	mm	mm	g
5045Z-10	3/8"	65	8	18.5
5045Z-12	1/2"	70	8	20.5
5045Z-16	5/8"	72	8	21.5
5045Z-19	3/4"	74	8	22.5

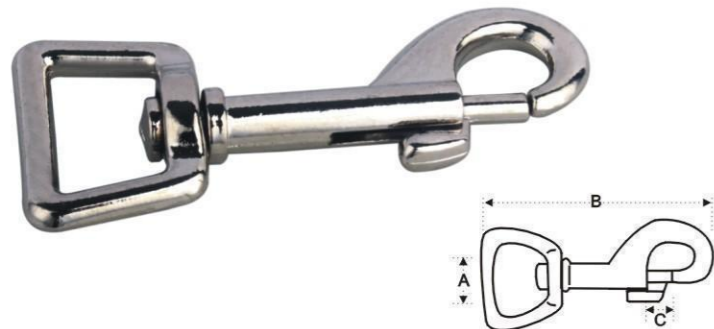

ART NO	A	B	C	NW
	inch	mm	mm	g
5045ZT-16	5/8"	70	8	19
5045ZT-19	3/4"	68	8	21
5045ZT-25	1"	70	8	22
5045ZTN-16	5/8"	67	8	18.5



ART NO	A	B	C	NW
	inch	mm	mm	g
5025Z-10	3/8"	75	11	26
5025Z-12	1/2"	76	11	26.5
5025Z-16	5/8"	80	11	27.5
5025Z-19	3/4"	82	11	29

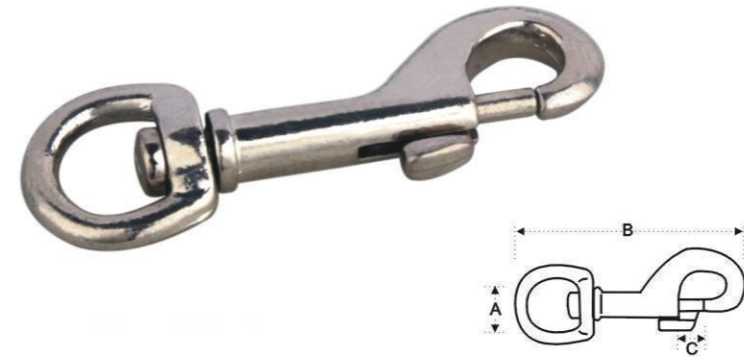

ART NO	A	B	C	NW
	inch	mm	mm	g
5025ZN-12	1/2"	79	11	29
5025ZN-19	3/4"	84	11	33
5025ZN-25	1"	86	11	38

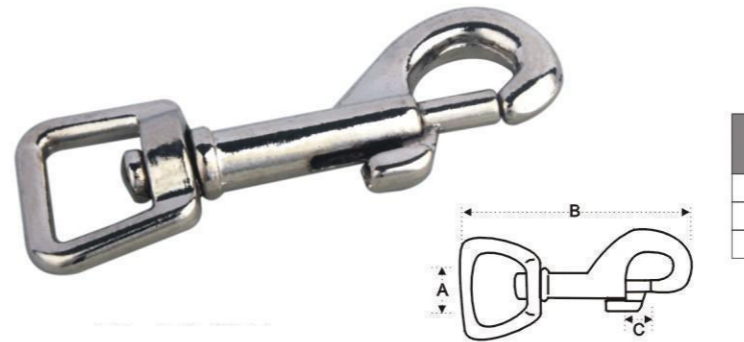

ART NO	A	B	C	NW
	inch	mm	mm	g
5025ZT-16	5/8"	75	11	28
5025ZT-19	3/4"	74	11	29
5025ZT-25	1"	74	11	31

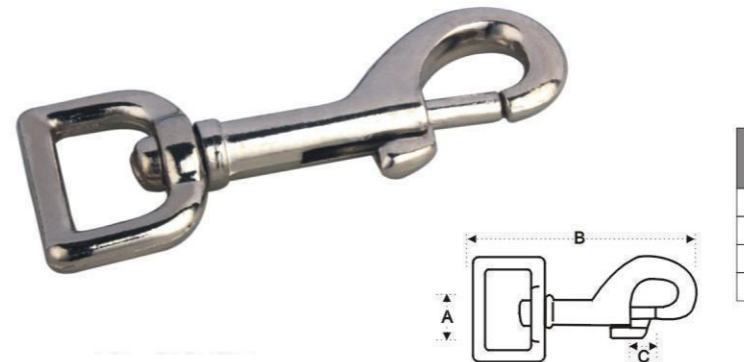

ART NO	A	B	C	NW
	inch	mm	mm	g
5026Z-16	5/8"	75	11	30
5026Z-19	3/4"	75	11	32
5026Z-25	1"	75	11	34
5026Z-38	1 1/2"	75	11	36



ART NO	A	B	C	NW
	inch	mm	mm	g
225Z-12	1/2"	84	11	40
225Z-16	5/8"	86	11	42
225Z-19	3/4"	90	11	43
225Z-22	7/8"	91	11	45
225Z-25	1"	93	11	46
225ZN-19	3/4"	87	11	43

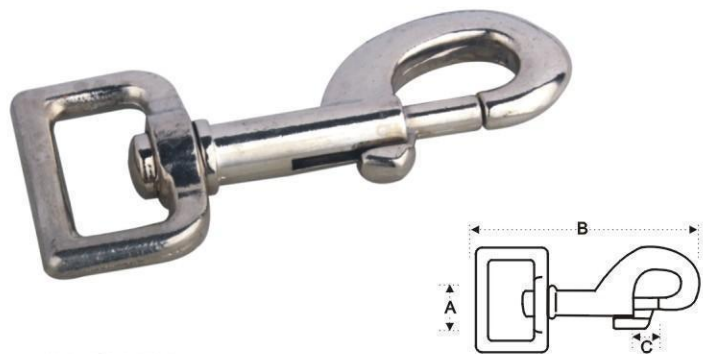

ART NO	A	B	C	NW
	inch	mm	mm	g
017Z-16	5/8"	80	11	39
017Z-19	3/4"	80	11	40
017Z-25	1"	80	11	42
017Z-32	1 1/4"	80	11	44
017Z-38	1 1/2"	80	11	47
017Z-50	2"	90	11	52



ART NO	A	B	C	NW
	inch	mm	mm	g
225HZ-16	5/8"	96	12	60
225HZ-19	3/4"	99	12	64
225HZ-25	1"	102	12	66
225HZ-28	1 1/8"	103	12	68
225HZ-32	1 1/4"	110	12	70
225HZH-25	1"	109	12	80



ART NO	A	B	C	NW
	inch	mm	mm	g
225ZT-16	5/8"	80	11	39
225ZT-19	3/4"	80	11	41
225ZT-25	1"	80	11	43



ART NO	A	B	C	NW
	inch	mm	mm	g
1001Z-12	1/2"	100		125
1001ZH-12	1/2"	100		143



ART NO	A	B	C	NW
	inch	mm	mm	g
225ZL-16	5/8"	90	10	42
225ZL-19	3/4"	90	10	44
225ZL-22	7/8"	95	10	47
225ZL-25	1"	97	10	48



ART NO	A	B	C	NW
	inch	mm	mm	g
1002Z-16	3/4"	107		137
1002Z-25	1"	107		139
1002Z-32	1 1/4"	107		142

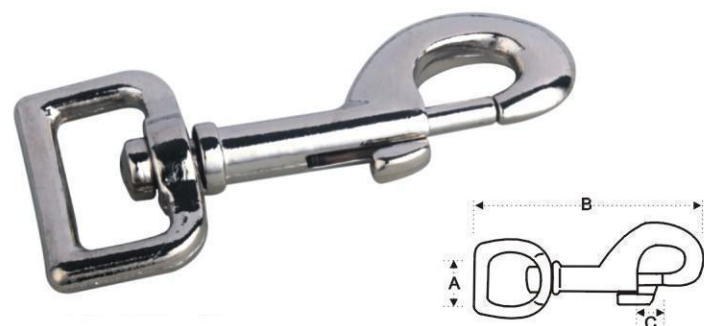

ART NO	A	B	C	NW
	inch	mm	mm	g
017ZL-19	3/4"	84	10	42
017ZL-25	1"	84	10	45
017ZL-32	1 1/4"	84	10	48



ART NO	A	B	C	NW
	inch	mm	mm	g
1003Z-19	3/4"	119		140
1003Z-25	1"	123		144
1003Z-32	1 1/4"	128		148

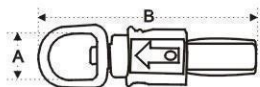

ART NO	A	B	C	NW
	inch	mm	mm	g
1011Z-19	3/4"	100		103
1011Z-25	1"	100		108

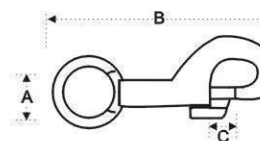

ART NO	A	B	C	NW
	inch	mm	mm	g
125Z-12	1/2"	83	12	34
125Z-16	5/8"	86	12	35
125Z-19	3/4"	88	12	36

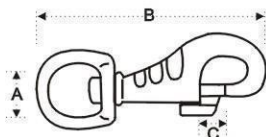

ART NO	A	B	C	NW
	inch	mm	mm	g
59Z-12	1/2"	85	12.5	43
59Z-16	5/8"	86	12.5	45
59Z-19	3/4"	91	12.5	46
59Z-22	7/8"	92	12.5	48
59Z-25	1"	94	12.5	49

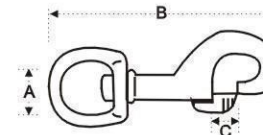

ART NO	A	B	C	NW
	inch	mm	mm	g
47Z-12	1/2"	72	10	39
47Z-16	5/8"	74	10	41
47Z-19	3/4"	78	10	42
47Z-22	7/8"	80	10	44
47Z-25	1"	82	10	45

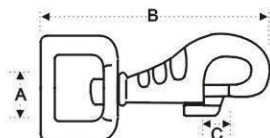

ART NO	A	B	C	NW
	inch	mm	mm	g
60Z-16	5/8"	80	12.5	42
60Z-19	3/4"	80	12.5	44
60Z-22	7/8"	80	12.5	45
60Z-25	1"	80	12.5	46

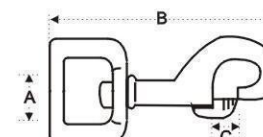

ART NO	A	B	C	NW
	inch	mm	mm	g
48Z-16	5/8"	70	10	39
48Z-19	3/4"	70	10	40
48Z-22	7/8"	70	10	41
48Z-25	1"	70	10	42

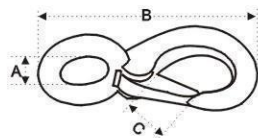

ART NO	A	B	C	NW
	mm	mm	mm	g
126Z-50	11	50	8	17
126Z-60	13	60	9	30
126Z-70	15	70	11	44
126Z-85	18	85	13	80
126Z-100	21	100	17	124
126Z-120	25	120	19	214

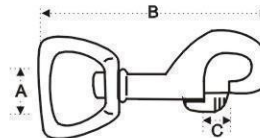

ART NO	A	B	C	NW
	inch	mm	mm	g
58ZT-16	5/8"	78	10	45
58ZT-19	3/4"	78	10	46
58ZT-25	1"	78	78	48



ART NO	A	B	C	NW
	inch	mm	mm	g
161Z	10	88	10	35
162Z	10	100	10	47
163Z	12	118	12	70



ART NO	A	B	C	NW
	inch	mm	mm	g
251Z-12	1/2"	81	12	50
251Z-16	5/8"	82	12	54
251Z-19	3/4"	86	12	56
251Z-22	7/8"	87	12	58
251Z-25	1"	89	12	60
251Z-32	1 1/4"	98	12	70



ART NO	A	B	C	NW
	inch	mm	mm	g
830ZS-10	3/8"	67	7	28
830ZS-12	1/2"	68	7	28.5
830ZS-16	5/8"	70	7	30
830ZS-19	3/4"	72	7	31



ART NO	A	B	C	NW
	inch	mm	mm	g
848ZS-16	5/8"	68	7	28.5
848ZS-19	3/4"	67	7	28.5
848ZS-25	1"	67	7	28.5



ART NO	A	B	C	NW
	inch	mm	mm	g
830Z-12	1/2"	84	10	50
830Z-16	5/8"	85	10	51
830Z-19	3/4"	90	10	52
830Z-22	7/8"	91	10	53
830Z-25	1"	93	10	55



ART NO	A	B	C	NW
	inch	mm	mm	g
848Z-16	5/8"	80	10	48
848Z-19	3/4"	80	10	49
848Z-22	7/8"	80	10	51
848Z-25	1"	80	10	52
848Z-32	1 1/4"	80	10	52
848Z-38	1 1/2"	80	10	57
848Z-50	2"	80	10	61



ART NO	A	B	C	NW
	inch	mm	mm	g
1605Z-25	1"	65	10	32
1605Z-38	1 1/2"	65	10	35



ART NO	A	B	C	NW
	inch	mm	mm	g
100Z-22	7/8"	61	9	45
100Z-25	1"	61	9	46
100Z-38	1 1/2"	61	9	50



ART NO	A	B	C	NW
	inch	mm	mm	g
3142Z-22	7/8"	100		120
3142Z-25	1"	100		120

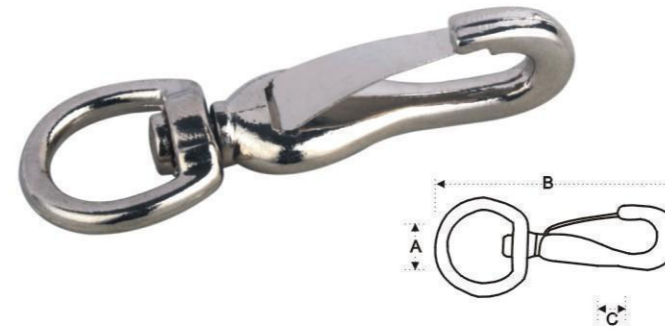

ART NO	A	B	C	NW
	inch	mm	mm	g
437Z-10	3/8"	63	5	16
437Z-12	1/2"	63	5	16.5
437Z-16	5/8"	65	5	18
437Z-19	3/4"	68	5	19



ART NO	A	B	C	NW
	inch	mm	mm	g
3143Z-25	1"	100		125
3143Z-32	1 1/4"	100		140

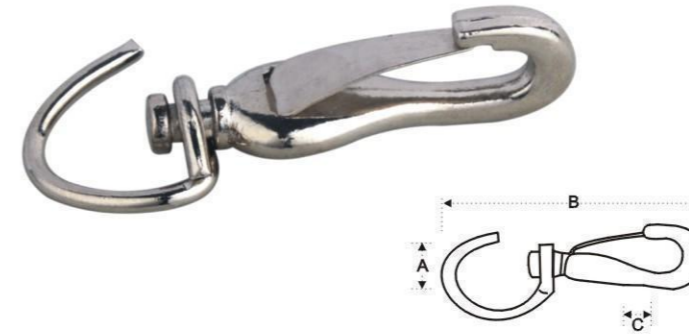

ART NO	A	B	C	NW
	inch	mm	mm	g
5037Z-10	3/8"	65	5	17.5



ART NO	A	B	C	NW
	inch	mm	mm	g
242ZS-12	1/2"	40		6
242ZS-16	5/8"	40		6
242ZS-19	3/4"	40		6
242ZS-25	1"	40		6.5



ART NO	A	B	C	NW
	inch	mm	mm	g
334Z-10	3/8"	50	5	10
334Z-12	1/2"	52	5	12



ART NO	A	B	C	NW
	inch	mm	mm	g
200Z-12	1/2"	75	12	31
200Z-16	5/8"	75	12	33
200Z-19	3/4"	75	12	34
200Z-22	7/8"	75	12	35
200Z-25	1"	75	12	36
200Z-32	1 1/4"	75	12	38



ART NO	A	B	C	NW
	inch	mm	mm	g
5013ZS-10	3/8"	63		26
5013ZS-12	1/2"	63		26.5
5013ZS-16	5/8"	65		28
5013ZS-19	3/4"	66		30



ART NO	A	B	C	NW
	inch	mm	mm	g
5015ZS-16	5/8"	62		28
5015ZS-19	3/4"	62		29
5015ZS-25	1"	62		31



ART NO	A	B	C	NW
	inch	mm	mm	g
844Z-2	3/32"			35
844Z-3	1/8"			35
834Z-3	1/8"			85



ART NO	A	B	C	NW
	inch	mm	mm	g
5013Z-10	3/8"	58		30
5013Z-12	1/2"	65		36
5013Z-16	5/8"	67		37
5013Z-19	3/4"	71		39
5013Z-22	7/8"	73		40
5013Z-25	1"	76		43

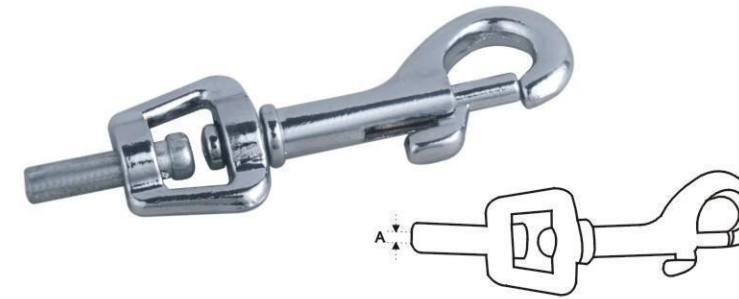

ART NO	A	B	C	NW
	mm	mm	mm	g
5079Z	1.5			15
5025Z	2.5			42
225Z	3.5			52



ART NO	A	B	C	NW
	inch	mm	mm	g
578Z-6	1/4"	40		5.5
578Z-10	3/8"	40		5.5

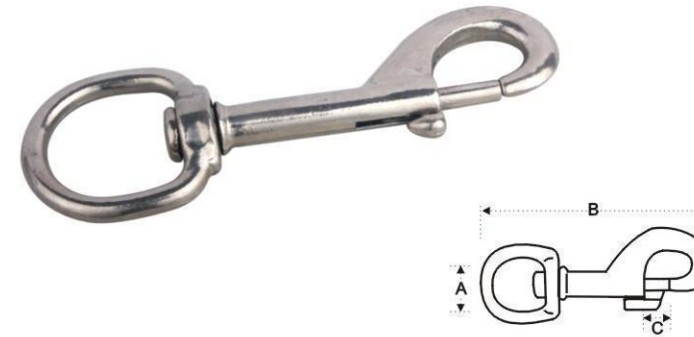

ART NO	A	B	C	NW
	inch	mm	mm	g
T225Z-28	1 1/8"	130		80

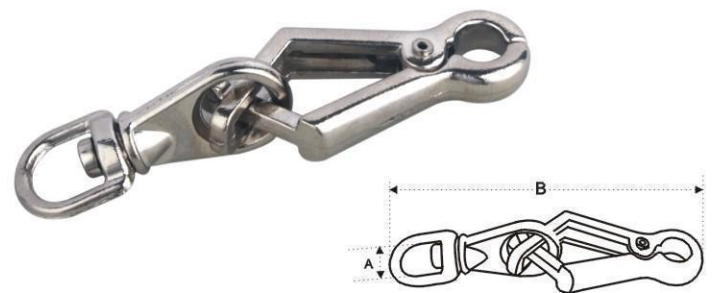

ART NO	A	B	C	NW
	inch	mm	mm	g
5051Z-6	1/4"	60		12
5051Z-10	3/8"	70		21
5051Z-12	1/2"	95		41
5051Z-16	5/8"	125		71



ART NO	A	B	C	NW
	inch	mm	mm	g
232Z-12	1/2"	50	4	7
232Z-19	3/4"	60	5.5	30



ART NO	A	B	C	NW
	inch	mm	mm	g
234Z-20	3/4"	45	5.5	8



ART NO	A	B	C	NW
	inch	mm	mm	g
236Z-38	1 1/2"	60	7	14



ART NO	A	B	C	NW
	inch	mm	mm	g
3726Z-19	3/4"	65	6	36
3726Z-25	1"	65	6	36.5

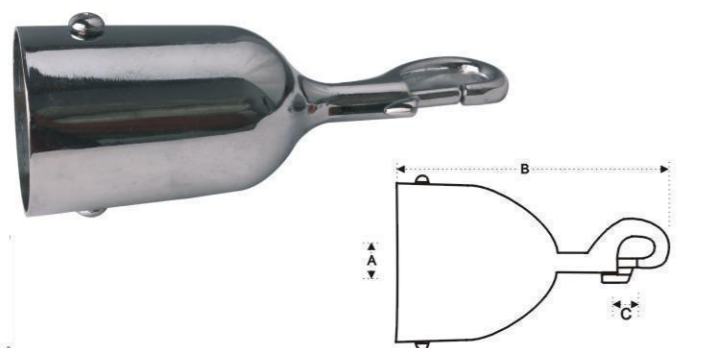

ART NO	A	B	C	NW
	inch	mm	mm	g
3238Z-40	1 1/2"	119	13	130



ART NO	A	B	C	NW
	inch	mm	mm	g
225B-16	5/8"	81	12	47
225B-19	3/4"	81	12	47
225B-25	1"	90	12	57



ART NO	A	B	C	NW
	inch	mm	mm	g
225HB-28	1 1/8"	114	17	108
225HB-32	1 1/4"	118	17	117



ART NO	A	B	C	NW
	inch	mm	mm	g
5025B-12	1/2"	76	7	21



ART NO	A	B	C	NW
	inch	mm	mm	g
249B-0	3/8"	54	7	20
249B-1	5/8"	69	7	34
249B-2	11/16"	80	12	44
249B-3	3/4"	95	16	96



ART NO	A	B	C	NW
	inch	mm	mm	g
251B-1	3/4"	86	10	64
251B-2	7/8"	93	13	75
251B-3	7/8"	115	15	117



ART NO	A	B	C	NW
	inch	mm	mm	g
334B-10	3/8"	53	5	12



ART NO	A	B	C	NW
	inch	mm	mm	g
9482Z-10	3/8"			3.5
9482Z-16	5/8"			12
9482Z-19	3/4"			16
9482Z-25	1"			32
9482Z-32	1 1/4"			45
9482Z-38	1 1/2"			55



ART NO	A	B	C	NW
	inch	mm	mm	g
161B	10	90	10	43
162B	11	100	11	47
163B	13	120	13	77



ART NO	A	B	C	NW
	inch	mm	mm	g
923Z-10	3/8"			5
923Z-12	1/2"			6
923Z-16	5/8"			8
923Z-19	3/4"			11
923Z-25	1"			21



ART NO	A	B	C	NW
	inch	mm	mm	g
3002B-25	1"	117	16	140



ART NO	A	B	C	NW
	inch	mm	mm	g
5706Z-19	3/4"			42
5706Z-25	1"			52



ART NO	A	B	C	NW
	inch	mm	mm	g
5013B-12	1/2"	67	15	37



ART NO	A	B	C	NW
	inch	mm	mm	g
2300Z-12	1/2"			2.5
2300Z-16	5/8"			3
2300Z-19	3/4"			3.5
2300Z-25	1"			6

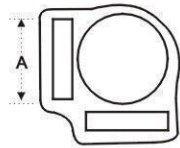

ART NO	A inch	B mm	C mm	NW g
369Z-19	3/4"			40
369Z-25	1"			50

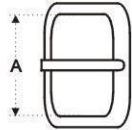

ART NO	A inch	B mm	C mm	NW g
75Z-19	3/4"			9
75Z-25	1"			14

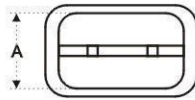

ART NO	A inch	B mm	C mm	NW g
2972Z-50	2"			52



ART NO	A inch	B mm	C mm	NW g
146Z-25	1"			52



5701Z



5702Z

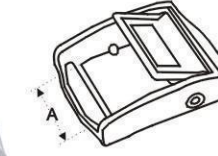

ART NO	A inch	B mm	C mm	NW g
5701Z-25	1"			66
5702Z-25	1"			42

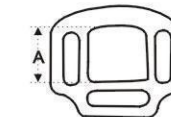

ART NO	A inch	B mm	C mm	NW g
370Z-19	3/4"			47
370Z-25	1"			57

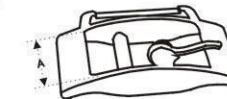

ART NO	A inch	B mm	C mm	NW g
144Z-30	1 1/4"	60		45

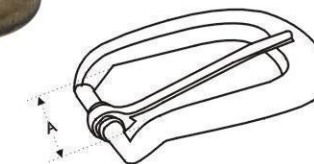

ART NO	A inch	B mm	C mm	NW g
258Z-25	1"			25.5

ROPE CLEATS

zoofurni tura. ru



ART NO	A inch	B inch	C mm	NW g
4014Z-10		70		11.5
4014Z-86		86		20
4014Z-110		110		43

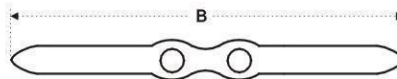

DR-4014Z



ART NO	A inch	B inch	C mm	NW g
4015Z-65		2-1/2"		10
4015Z-110		4-1/2"		33
4015Z-150		6"		58

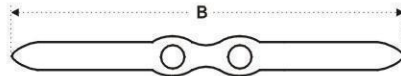

DR-4015Z



ART NO	A inch	B inch	C mm	NW g
4016Z-110		4-1/2"		33

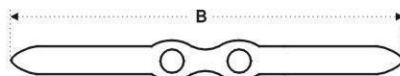

DR-4016Z

SWIVEL RINGS

zoofurni.tura.ru



DR-180Z

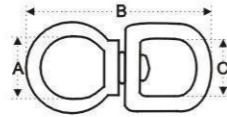

ART NO	A	B	C	NW
	inch	mm	mm	g
180Z-6X8	6	25	8	3.5
180Z-10X10	10	35	10	10
180Z-10X12	10	40	12	11
180Z-9X13	9	47	13	21
180Z-9X16	9	49	16	23



DR-7913Z

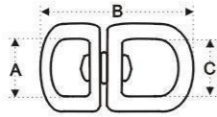

ART NO	A	B	C	NW
	inch	mm	mm	g
7931Z-3/4" X3/4"	3/4"	60	3/4"	36
7931Z-3/4" X1"	3/4"	60	1"	39
7931Z-1" X3/4"	1"	60	3/4"	37
7931Z-1" X1"	1"	60	1"	40



DR-178Z

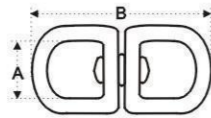

ART NO	A	B	C	NW
	inch	mm	mm	g
178Z-10	3/8"	38		12
178Z-12	1/2"	52		21
178Z-16	5/8"	62		33
178Z-19	3/4"	70		37
178Z-22	7/8"	72		42
178Z-25	1"	78		46
178Z-28	1 1/8"	80		50
178Z-32	1 1/4"	92		62



DR-179Z

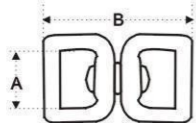

ART NO	A	B	C	NW
	inch	mm	mm	g
179Z-16	5/8"	50		31
179Z-19	3/4"	50		33
179Z-22	7/8"	50		35
179Z-25	1"	50		37

EUROPEAN SWIVEL EYE AND EYE

STAINLESS STEEL AISI316
STAINLESS STEEL AISI304
STEEL ELECTRIC GALVANIZED

DR-Z216

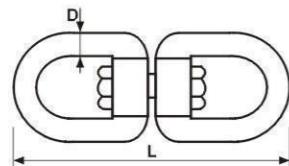

Size	D	L
mm	mm	mm
5	5	59
6	6	65
8	8	90
10	10	115
13	13	152
16	16	188
19	19	229

WIRE ROPE CLIPS WALL HOOKS

zoofurni.tura.ru



DR-514Z

ART NO	A	B	C	NW
	mm	mm	mm	g
514Z-2	2			17
514Z-3	3			17.5
514Z-4	4			36
514Z-5	5			39
514Z-6	6			49



DR-7316Z

ART NO	A	B	C	NW
	inch	mm	mm	g
7316Z-1/8"	1/8"			17
7316Z-3/16"	3/16"			21
7316Z-1/4"	1/4"			29



DR-7300Z

ART NO	A	B	C	NW
	inch	mm	mm	g
7300Z	1/8"			14
7300Z	3/16"			21.5
7300Z	1/4"			28

WALL HOOKS



DR-EC5Z

ART NO	A	B	C	NW
	inch	mm	mm	g
EC5Z	21	42		13.4



DR-850Z

WALL HOOKS

ART NO	A	B	C	NW
	inch	mm	mm	g
850Z	19	110		35

WIRE ROPE CLIPS

DIN 741 WIRE ROPE CLIPS

STAINLESS STEEL AISI316
STAINLESS STEEL AISI304
STEEL ELECTRIC GALVANIZED

DR-Z0010

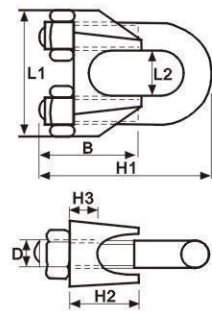

Size mm	D mm	B mm	H1 mm	H2 mm	H3 mm	L1 mm	L2 mm
3mm	M4	12	20	7.5	3.7	17.8	4.8
5mm	M5	13	24	8.2	3.9	22	5.1
6mm	M5	13	28	10.6	5	23.5	7
8mm	M6	20	34	11.7	6	27.4	9.5
10mm	M8	21	42	13	6.3	31.8	10
11mm	M8	24.5	44.5	16	6.5	36.5	12
13mm	M10	30	55	19.5	7.5	42	13
14mm	M10	30	57	23.8	7.7	44	14.5
16mm	M12	33	63.5	26.2	9.5	49.5	17.6
19mm	M12	38	75	31.3	10.8	54.4	22.5
22mm	M12	44	85	34.5	10.8	57.5	22.9
26mm	M14	45	95	35	11	64	27.5

U.S TYPE WIRE ROPE CLIPS

STAINLESS STEEL AISI316
STAINLESS STEEL AISI304
STEEL ELECTRIC GALVANIZED

DR-Z0011

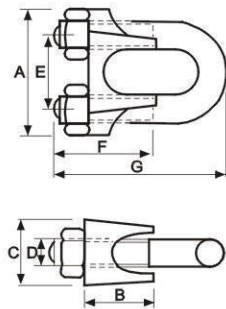

Size(inch) mm	A mm	B mm	C mm	D mm	E mm	F mm	G mm
1/16	13/16	13/12	15/32	3/16	3/8	1/2	23/32
1/8	7/8	7/16	9/16	3/16	7/16	9/16	25/32
3/16	1 1/32	1/2	9/32	1/4	9/16	21/32	15/16
1/4	1 1/4	19/32	23/32	5/16	21/32	25/32	1 1/4
5/16	1 3/8	5/8	25/32	5/16	23/32	7/8	1 1/2
3/8	1 1/2	7/8	7/8	3/8	7/8	1 1/16	1 27/32
7/16	1 3/4	29/32	29/32	3/8	31/32	1 3/16	1 29/32
1/2	1 15/16	29/32	1 1/32	7/16	1 1/16	1 3/8	2 1/8
9/16	2 1/8	1 1/32	1 3/32	1/2	1 3/16	1 3/8	2 1/8
5/8	2 1/4	1 3/32	1 1/8	1/2	1 1/16	1 3/8	2 1/32
3/4	2 19/32	1 11/32	1 1/4	9/16	1 3/8	1 29/32	2 11/16
7/8	2 13/16	1 1/2	1 15/32	5/8	1 1/8	1 13/16	3 1/16
1	3 1/16	1 11/16	1 27/32	5/8	1 29/32	2 3/32	3 7/16

SIMPLEX WIRE ROPE CLIP

STAINLESS STEEL AISI316
STAINLESS STEEL AISI304
STEEL ELECTRIC GALVANIZED

DR-Z0012

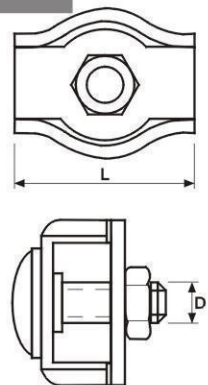

Size mm	L mm	D mm
2		M4
3	20	M4
4	21.5	M5
5	26	M6
6	30	M6
8	36	M8
10	42	M10

DUPLEX WIRE ROPE CLIP

STAINLESS STEEL AISI316
STAINLESS STEEL AISI304
STEEL ELECTRIC GALVANIZED

DR-Z0013

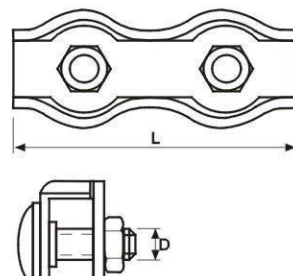

Size mm	L mm	D mm
2	37	M4
3	40	M4
4	43	M5
5	52	M6
6	60	M6
8	72	M8
10	84	M10

PULLEYS

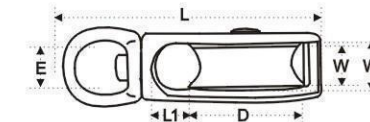

SIZE	D	DIA ROPE SIZE	L	L1	W	W1	E	GM/PC
0172Z	25	7	64	9.5	10	15	12	47

DR-0172Z SWIVEL EYE

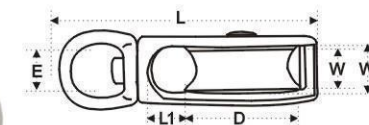

SIZE	D	DIA ROPE SIZE	L	L1	W	W1	E	GM/PC
1/2"	1/2"	5/32"	1 15/16"	11/32"	5/16"	9/32"	7/16"	19
3/4"	3/4"	3/16"	1 11/16"	1/4"	5/16"	9/32"	7/16"	27
1"	1"	1/4"	2 3/8"	3/8"	13/32"	3/8"	7/16"	47
1 1/4"	1 1/4"	5/16"	3 1/2"	1/2"	17/32"	1/2"	13/16"	80
1 1/2"	1 1/2"	3/8"	3 1/2"	13/32"	17/32"	1/2"	13/16"	95
2"	2"	7/16"	4 1/4"	9/16"	9/16"	1/2"	13/16"	166

DR-0173Z SWIVEL EYE

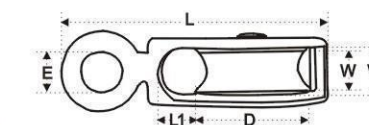

SIZE	D	DIA ROPE SIZE	L	L1	W	W1	E	GM/PC
1/2"	1/2"	5/32"	1 5/8"	11/32"	5/16"	9/32"	3/16"	15
3/4"	3/4"	3/16"	1 5/8"	1/4"	5/16"	5/16"	3/16"	24
1"	1"	1/4"	2 1/8"	3/8"	13/32"	3/8"	1/4"	43
1 1/4"	1 1/4"	5/16"	3"	1/2"	17/32"	1/2"	3/8"	70
1 1/2"	1 1/2"	3/8"	3"	13/32"	17/32"	1/2"	3/8"	85
2"	2"	7/16"	3 7/8"	9/16"	9/16"	1/2"	1/2"	170

DR-0174Z RIGID EYE

PULLEYS

zoofurni tura. ru

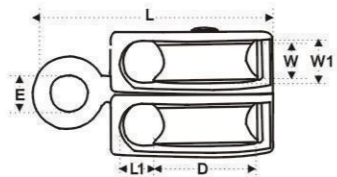

SIZE	D	DIA ROPE SIZE	L	L1	W	W1	E	GM/PC
1/2"	1/2"	5/32"	1 5/8"	11/32"	5/16"	9/32"	3/16"	24
3/4"	3/4"	3/16"	1 5/8"	1/4"	5/16"	5/16"	3/16"	36
1"	1"	1/4"	2 1/8"	3/8"	13/32"	3/8"	1/4"	69
1 1/4"	1 1/4"	5/16"	3"	1/2"	17/32"	1/2"	3/8"	115
1 1/2"	1 1/2"	3/8"	3"	13/32"	17/32"	1/2"	3/8"	140
2"	2"	7/16"	3 7/8"	9/16"	9/16"	1/2"	1/2"	282

DR-0176Z RIGID EYE

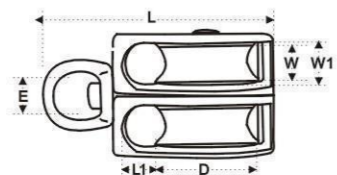

SIZE	D	DIA ROPE SIZE	L	L1	W	W1	E	GM/PC
1/2"	1/2"	5/32"	1 15/16"	11/32"	5/16"	9/32"	7/16"	28
3/4"	3/4"	3/16"	1 15/16"	1/4"	5/16"	5/16"	7/16"	40
1"	1"	1/4"	2 3/8"	3/8"	13/32"	3/8"	7/16"	73
1 1/4"	1 1/4"	5/16"	3 1/2"	1/2"	17/32"	1/2"	13/16"	126
1 1/2"	1 1/2"	3/8"	3 1/2"	13/32"	17/32"	1/2"	13/16"	142
2"	2"	7/16"	4 1/8"	9/16"	9/16"	1/2"	13/16"	283

DR-0178Z SWIVEL EYE

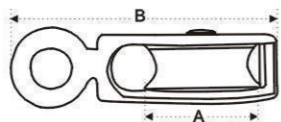

ART NO	A	B	C	NW
	inch	mm	mm	g
7310B-25	1"	52		54
7310B-38	1 1/2"	81		126

DR-7310B

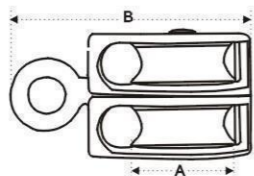

ART NO	A	B	C	NW
	inch	mm	mm	g
7320B-25	1"	52		77
7320B-38	1 1/2"	81		217

DR-7320B-38

PULLEYS

zoofurni tura. ru

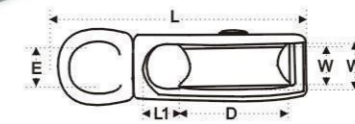

DR-502Z

ART NO	D	L	E	NW
	mm	mm	mm	g
502Z-15	15	49	10	21
502Z-20	20	59	11	36
502Z-25	25	70	12	52
502Z-30	30	76	13	77
502Z-40	40	90	16	110
502Z-50	50	110	17	175
502Z-65	65	133	18	360

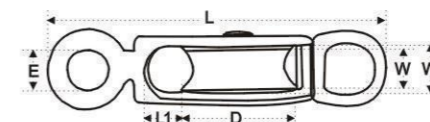

DR-503Z

ART NO	D	L	E	NW
	mm	mm	mm	g
503Z-30	30	100	13	103

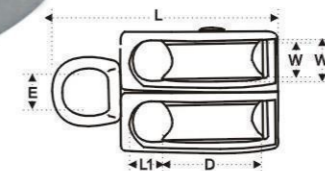

DR-504Z

ART NO	D	L	E	NW
	mm	mm	mm	g
504Z-15	15	49	10	34
504Z-20	20	58	11	55
504Z-25	25	70	12	72
504Z-30	30	80	13	115
504Z-40	40	90	16	190
504Z-50	50	100	17	293

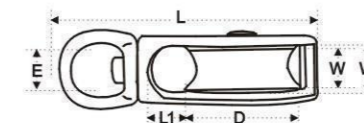

DR-505Z

ART NO	D	L	E	NW
	mm	mm	mm	g
505Z-15	15	50	10	20
505Z-20	20	55	11	36.5
505Z-25	25	75	12	64.5
505Z-30	30	85	13	94.5
505Z-40	40	90	16	130
505Z-50	50	105	17	225

PULLEYS

zoofurni tura. ru



DR-0270Z

ART NO	A mm	B mm	C mm	NW g
0270Z-30	30			45
0270Z-50	50			58



DR-0271Z

ART NO	A mm	B mm	C mm	NW g
0271Z-30	30			40
0271Z-50	50			80



DR-0272Z

ART NO	A mm	B mm	C mm	NW g
0272Z-25	25			49
0272Z-30	30			48
0272Z-35	35			56
0272Z-40	40			72
0272Z-50	50			83
0272Z-60	60			118

TURNBUCKLES

zoofurni tura. ru

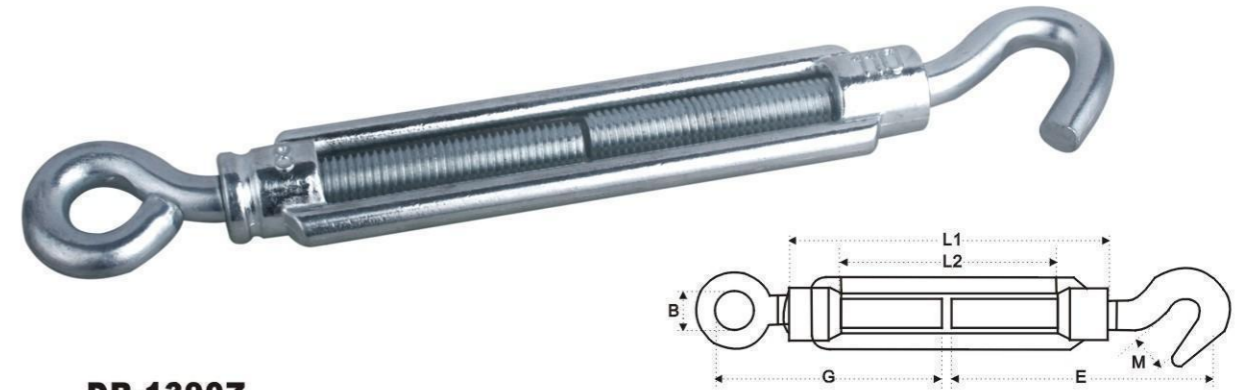

DR-1390Z

SIZE	L1	L2	b	g	e	m	NW
	mm	mm	mm	mm	mm	mm	mm
M5X50	50	30	8	43	43	7	30
M5X70	70	50	9	50	50	7	37
M6X60	60	35	10	52	50	8	50
M6X100	100	70	10	70	70	10	67
M8X70	70	45	11	60	55	11	85
M8X110	110	80	11	80	75	11	125
M10X80	80	50	12	70	60	11	156
M10X120	120	80	15	100	95	16	195
M12X130	130	90	15	105	100	15	385



DR-1391Z

SIZE	OVERALL LGTH-CLOSED	OVERALL LGTH-OPEN	TAKE UP	I.D.EYE	HOOK RADIUS	NW
5/32"	3 ³ / ₈ "	4 ³ / ₄ "	1 ³ / ₈ "	1/4"	1/4"	18
3/16"	3 ⁷ / ₈ "	5 ¹ / ₂ "	1 ⁵ / ₈ "	5/16"	5/16"	26.5
7/32"	4 ³ / ₈ "	6 ¹ / ₄ "	1 ⁷ / ₈ "	3/8"	3/8"	48
1/4"	5 ¹ / ₂ "	7 ³ / ₄ "	2 ¹ / ₈ "	3/8"	3/8"	61
5/16"	6 ³ / ₄ "	9 ³ / ₈ "	2 ⁵ / ₈ "	7/16"	7/16"	105
3/8"	7 ³ / ₄ "	10 ¹ / ₂ "	3"	1/2"	1/2"	171

TURNBUCKLES

TURNBUCKLE DIN 1480

STAINLESS STEEL AISI316
STAINLESS STEEL AISI304
STEEL ELECTRIC GALVANIZED
STEEL SELF COLOR

DR-Z0006



- HOOK/EYE
- HOOK/HOOK
- EYE/EYE

SIZE(D)	L	B	C
mm	mm	mm	mm
M5	70	90	8
M6	110	172-252	9
M8	110	182-257	10
M10	125	213-298	14
M12	125	238-318	16
M14	140	263-353	18
M16	170	320-430	22
M20	200	367-497	24

TURNBUCKLE EUROPEAN TYPE

STAINLESS STEEL AISI316
STAINLESS STEEL AISI304
STEEL ELECTRIC GALVANIZED
STEEL SELF COLOR

DR-Z0007

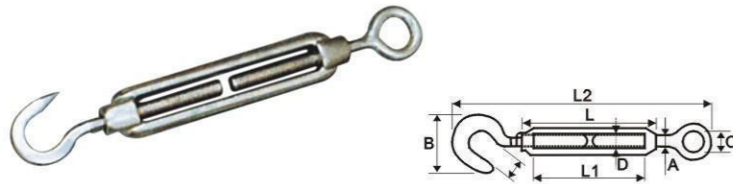

- HOOK/EYE
- HOOK/HOOK
- EYE/EYE

D	L	L1	L2	B	C	S
mm	mm	mm	mm	mm	mm	mm
3/16" (5mm)	70	52	120	13	8	9
1/4" (6mm)	90	78	160	16	10	10
5/16" (8mm)	120	100	200	20	14	11
3/8" (10mm)	150	120	240	28	16	12
1/2" (12mm)	200	168	300	36	18	14
5/8" (16mm)	250	210	390	40	26	16
3/4" (20mm)	300	250	440	50	30	18

TURNBUCKLE EUROPEAN TYPE

STAINLESS STEEL AISI316
STAINLESS STEEL AISI304
STEEL ELECTRIC GALVANIZED
STEEL SELF COLOR

DR-Z0008

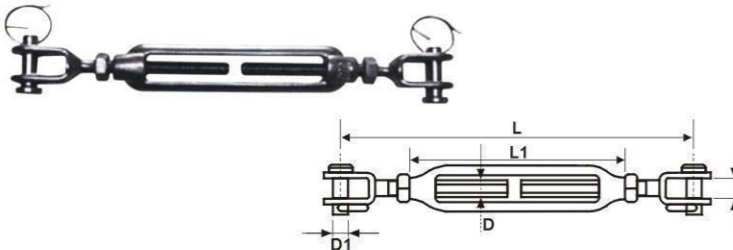

SIZE(D)	L	L1	A	D1
mm	mm	mm	mm	mm
M5	121	70	6	5.2
M6	145	90	7.5	6.2
M8	180	120	10	8.7
M10	225	150	12	9.7
M12	300	200	14	12.6
M16	380	250	16	16

TURNBUCKLES SERIES



DR-1389Z

SIZE(D)	L	L1	A	NW
mm	mm	mm	mm	g
1389Z	60	34		50

SHACKLES

EUROPEN TYPE DEE SHACKLE

STAINLESS STEEL AISI316
STAINLESS STEEL AISI304
STEEL ELECTRIC GALVANIZED

DR-Z0001

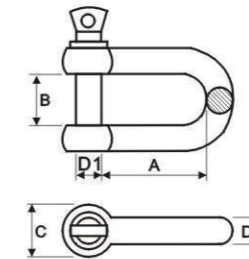

D	A	B	C	D1
mm	mm	mm	mm	mm
4	14	8	8	4
5	17	10	10	5
6	21	12	12	6
8	28	16	16	8
10	35	20	20	10
12	42	24	24	12
14	48	28	28	14
16	56	32	32	16
18	63	36	36	18
20	70	40	40	20
22	77	44	44	22
25	87	50	50	25

EUROPEAN TYPE BOW SHACKLE

STAINLESS STEEL AISI316
STAINLESS STEEL AISI304
STEEL ELECTRIC GALVANIZED

DR-Z0002

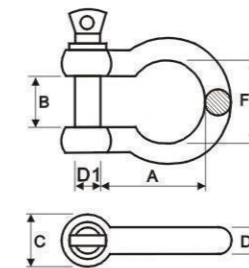

D	A	B	C	D1	F
mm	mm	mm	mm	mm	mm
4	16	8	8	4	12
5	20	10	10	5	15
6	24	12	12	6	18
8	32	16	16	8	24
10	40	20	20	10	30
12	48	24	24	12	36
14	56	28	28	14	42
16	64	32	32	16	48
18	72	36	36	18	54
20	80	40	40	20	60
22	88	44	44	22	66
25	100	50	50	25	75

LONG DEE SHACKLE

STAINLESS STEEL AISI316
STAINLESS STEEL AISI304
STEEL ELECTRIC GALVANIZED

DR-Z0003

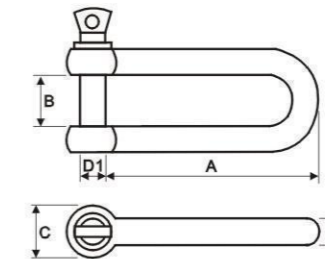

D	A	B	C	D1
mm	mm	mm	mm	mm
4	30	8	8	4
5	37	10	10	5
6	45	12	12	6
8	60	16	16	8
10	75	20	20	10
12	90	24	24	12
14	105	28	28	14
16	120	32	32	16

US TYPE ANCHOR SHACKLE

STAINLESS STEEL AISI316
STAINLESS STEEL AISI304
STEEL ELECTRIC GALVANIZED

DR-Z0004

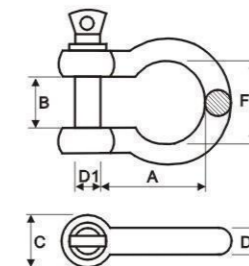

D	A	B	C	D1	F
mm	mm	mm	mm	mm	mm
3/16	22	9.5	14	1/4	15
1/4	28	12	15.5	5/16	20
5/16	31	13	19	3/8	21
3/8	36	16	23	7/16	26
7/16	42	18	27	1/2	29
1/2	48	21	30	5/8	33
5/8	60	27	38	3/4	43
3/4	71	32	46	7/8	51
7/8	84	36	53	1	58
1	95	43	60	1 1/8	68

SHACKLES

US TYPE SHACKLE

STAINLESS STEEL AISI316
STAINLESS STEEL AISI304
STEEL ELECTRIC GALVANIZED
DR-Z0053

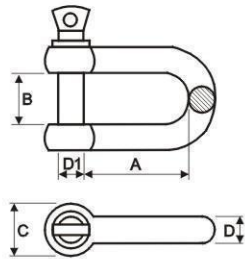

D	A	B	C	D1
mm	mm	mm	mm	mm
3/16		9.5	14.1	1/4
1/4		12	15.5	5/16
5/16		13	19	3/8
3/8		16	23	7/16
7/16	42	18	27	1/2
1/2		21	30	5/8
5/8		27	38	3/4
3/4	71	32	46	7/8
7/8	84	36	53	1
1	95	43	60	1 1/8

JIS TYPE DEE SHACKLE

STAINLESS STEEL AISI316
STAINLESS STEEL AISI304
DR-Z0054

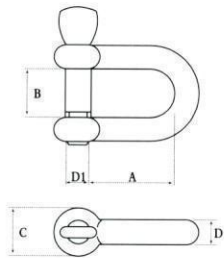

D	A	B	C	D1
mm	mm	mm	mm	mm
4	14	8	8	4
5	18	10	10	5
6	21	12	12	6
8	28	16	16	8
10	35	20	20	10
12	46	26	24	12
16	56	32	32	16
18	63	36	36	18
20	70	40	40	20
22	77	44	44	22
25	88	50	50	25

JIS TYPE BOW SHACKLE

STAINLESS STEEL AISI316
STAINLESS STEEL AISI304
DR-Z0055

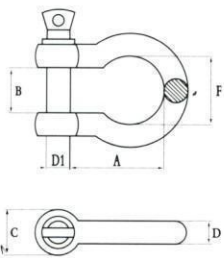

D	A	B	C	D1	F
mm	mm	mm	mm	mm	mm
4	18	8	8	4	14
5	22	10	10	5	17
6	27	13	12	6	21
8	37	16	16	8	28
10	46	19	20	10	35
12	54	25	24	12	42
16	74	32	32	16	56

TWIST SHACKLE

STAINLESS STEEL AISI316
STAINLESS STEEL AISI304
DR-Z0056

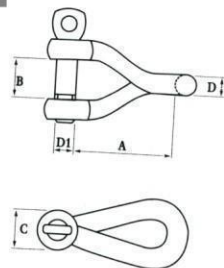

D	A	B	C	D1
mm	mm	mm	mm	mm
4	23	8	8	4
5	28	10	10	5
6	33	13	12	6
8	44	16	16	8
10	55	20	20	10
12	66	25	25	12

THIMBLES

THIMBLE DIN 6899A

STAINLESS STEEL AISI316
STAINLESS STEEL AISI304
STEEL ELECTRIC GALVANIZED
DR-Z0057

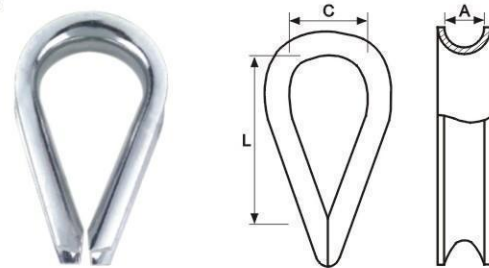

Size-∅	A	L	C	Size-∅	A	L	C
mm	mm	mm	mm	mm	mm	mm	mm
2.5	3.0	21.5	10	10.0	11.0	47.5	22
3.0	3.5	23.5	11	11.0	12.0	51.5	24
3.5	4.0	26.5	12	12.0	13.0	56.5	26
4.0	5.0	28.5	13	13.0	14.0	61.0	28
5.0	6.0	30.0	14	15.0	16.0	69.5	32
6.0	7.0	33.0	15	16.0	18.0	78.0	35
7.0	8.0	35.0	16	18.0	20.0	86.5	40
8.0	9.0	39.0	18	20.0	22.0	95.0	44
9.0	10.0	43.0	20	24/26	26.0	105.0	48

U.S THIMBLE G411

STAINLESS STEEL AISI316
STAINLESS STEEL AISI304
STEEL ELECTRIC GALVANIZED
DR-Z0058

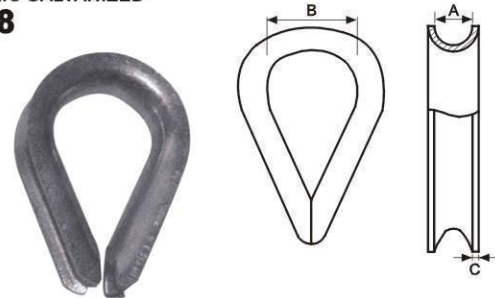

Size-∅	A	B	C
mm	mm	mm	mm
1/8"	17	33	1.2
3/16"	17.5	33	1.2
1/4"	18	33	1.2
5/16"	20.5	38	1.2
3/8"	24	42	1.5
1/2"	29	48	2
5/8"	35	57	3
3/4"	41	64	3.5
7/8"	48	89	4
1"	64	108	4
1 1/8-1 1/4"	70	115	5.5

U.S THIMBLE G414

STAINLESS STEEL AISI316
STAINLESS STEEL AISI304
STEEL ELECTRIC GALVANIZED
DR-Z0059

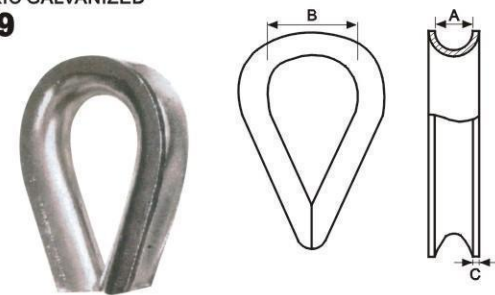

Size-∅	A	B	C
mm	mm	mm	mm
1/4"	22	41	1.5
5/16"	27	48	2
3/8"	29	54	3
7/16"	32	61	3
1/2"	38	70	3.5
9/16"	38	72	3.5
5/8"	44	82	4
3/4"	51	95	5.5
7/8"	57	108	5.5
1"	64	114	6
1 1/8-1 1/4"	73	130	6

THIMBLES EUROPEAN COMMERCIAL

STAINLESS STEEL AISI316
STAINLESS STEEL AISI304
STEEL ELECTRIC GALVANIZED
DR-Z0060

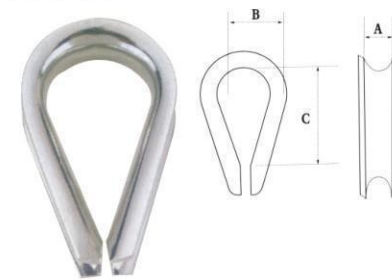

Size-∅	A	B	C	Size-∅	A	B	C
mm	mm	mm	mm	mm	mm	mm	mm
4	4	11	16	12	12	38	51
5	5	16	22	14	14	40	57
6	6	19	26	16	16	42	60
7	7	22	32	18	18	45	67
8	8	24	34	20	20	51	76
9	9	29	38	22	22	54	83
10	10	32	42	24	24	64	88
11	11	35	48	26	26	68	102
				28	28	73	110

SNAP HOOKS

zoofurni tura. ru

SNAP HOOK WITH EYELET DIN5299 FORM A

STAINLESS STEEL AISI316
STAINLESS STEEL AISI304
STEEL ELECTRIC GALVANIZED

DR-Z0019

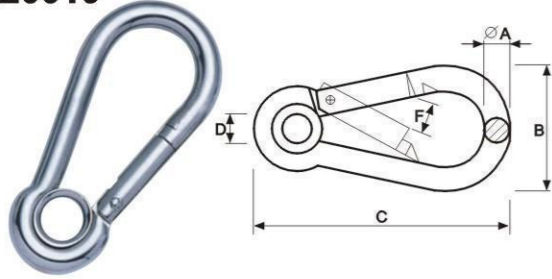

SIZE mm	∅A mm	B mm	C mm	D mm	F mm	W.L.L. mm
4X40	4	20	40	5	7	80
5X50	5	25	50	5	7	100
6X60	6	30	60	5	8	140
7X70	7	35	70	7	8	200
8X80	8	40	80	10	9	250
9X90	9	45	90	10	10	280
10X100	10	50	100	13	11	400
11X120	11	57	120	13	16	500
12X140	12	67	140	15	19	600
13X160	13	74	160	17	25	700
14X180	14	86	180	17	35	900

SNAP HOOK DIN5299 FORM C

STAINLESS STEEL AISI316
STAINLESS STEEL AISI304
STEEL ELECTRIC GALVANIZED

DR-Z0021

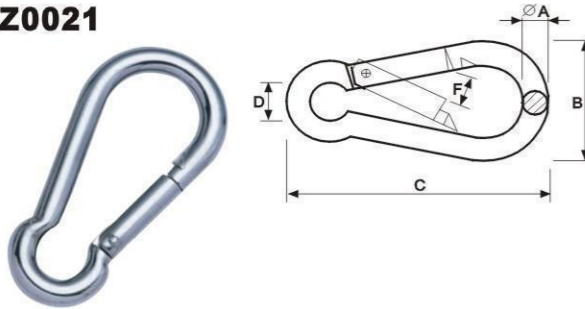

SIZE mm	∅A mm	B mm	C mm	D mm	F mm	W.L.L. mm
4X40	4	20	40	7	7	80
5X50	5	25	50	8	7	100
6X60	6	30	60	9	8	140
7X70	7	35	70	10	8	200
8X80	8	40	80	12	9	250
9X90	9	45	90	12	10	280
10X100	10	50	100	15	11	400
11X120	11	57	120	18	16	500
12X140	12	67	140	20	19	600
13X160	13	74	160	22	25	700
14X180	14	86	180	22	35	900

SNAP HOOK WITH SCREW DIN 5299 FORM D

STAINLESS STEEL AISI316
STAINLESS STEEL AISI304
STEEL ELECTRIC GALVANIZED

DR-Z0022

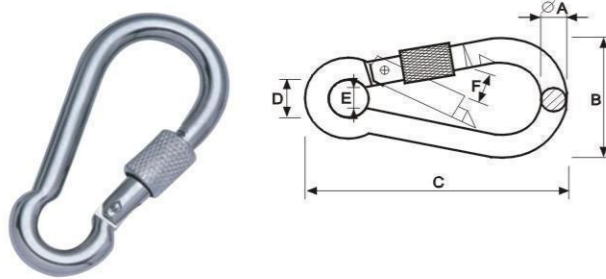

SIZE mm	∅A mm	B mm	C mm	D mm	F mm	W.L.L. mm
4X40	4	20	40	7	7	80
5X50	5	25	50	8	7	100
6X60	6	30	60	9	8	140
7X70	7	35	70	10	8	200
8X80	8	40	80	12	9	250
9X90	9	45	90	12	10	280
10X100	10	50	100	15	11	400
11X120	11	57	120	18	16	500
12X140	12	67	140	20	19	600
13X160	13	74	160	22	25	700
14X180	14	86	180	22	35	900

SNAP HOOK WITH EYELET AND SCREW

STAINLESS STEEL AISI316
STAINLESS STEEL AISI304
STEEL ELECTRIC GALVANIZED

DR-Z0023

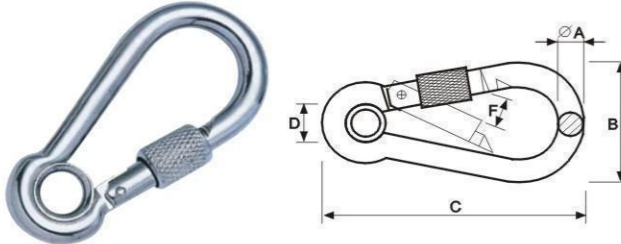

SIZE mm	∅A mm	B mm	C mm	D mm	F mm	W.L.L. mm
5X50	5	25	50	8	7	100
6X60	6	30	60	9	8	140
7X70	7	35	70	10	8	200
8X80	8	40	80	12	9	250
9X90	9	45	90	12	10	280
10X100	10	50	100	15	11	400
11X120	11	57	120	18	16	500
12X140	12	67	140	20	19	600
13X160	13	74	160	22	25	700
14X180	14	86	180	22	35	900

SNAP HOOKS

zoofurni tura. ru

EGG TYPE SNAP HOOK DIN5299 FORM B

STAINLESS STEEL AISI316
STAINLESS STEEL AISI304
STEEL ELECTRIC GALVANIZED

DR-Z0020

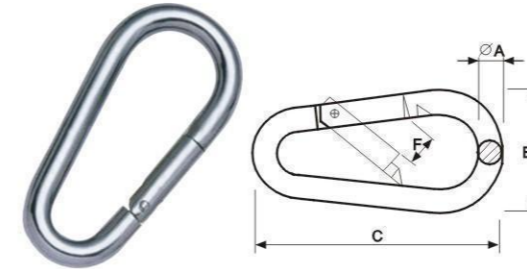

SIZE mm	∅A mm	B mm	C mm	F mm	W.L.L. mm
5X50	5	25	50	7	100
6X60	6	30	60	8	140
7X70	7	35	70	8	200
8X80	8	40	80	9	250
9X90	9	45	90	10	280
10X100	10	50	100	11	400
11X120	11	57	120	16	500
12X140	12	67	140	19	600

STEEL OBLIUE ANGLE SNAP HOOK

STAINLESS STEEL AISI316
STAINLESS STEEL AISI304
STEEL ELECTRIC GALVANIZED

DR-Z0024

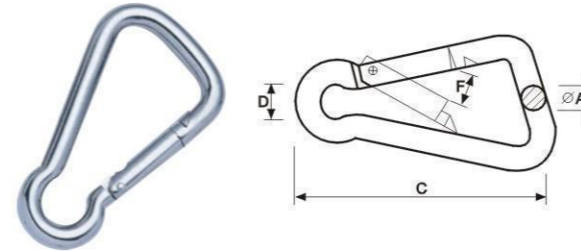

SIZE mm	∅A mm	C mm	D mm	F mm	W.L.L. LBS
5X50	5	50	8	9	100
6X60	6	60	9	10	140
8X80	8	80	12	13	250
10X100	10	100	15	18	400
11X120	11	120	15	24	500

QUICK LINK

STAINLESS STEEL AISI316
STAINLESS STEEL AISI304
STEEL ELECTRIC GALVANIZED

DR-Z0026

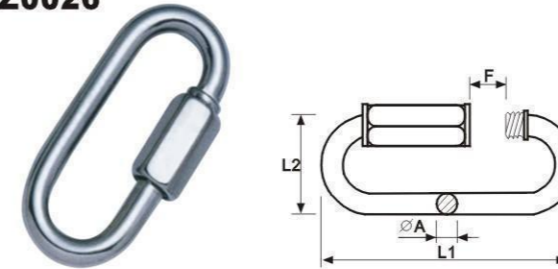

SIZE mm	∅A mm	L1 mm	L2 mm	F mm	W.L.L. mm
3.5	3.5	36.5	17	5	175
4	4	40	19.5	5.5	500
5	5	49	23	6.5	650
6	6	58	26.5	7.5	875
7	7	65	30.5	8.5	1200
8	8	75	33.5	10.5	1525
9	9	82	35	11.5	1975
10	10	90	40.5	12.5	2300
12	12	107	47.5	14.5	2500
14	14	125	54.5	17	2800

PEAR SHAPED QUICK LINK

STAINLESS STEEL AISI316
STAINLESS STEEL AISI304
STEEL ELECTRIC GALVANIZED

DR-Z0028

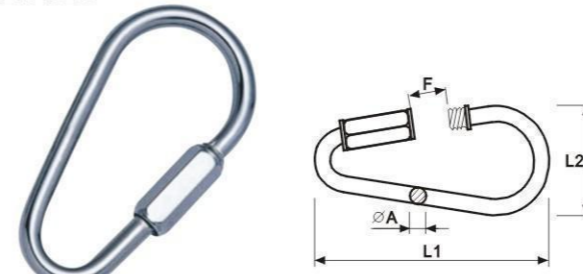

∅A mm	L1 mm	L2 mm	F mm	W.L.L. mm
3.5	52	27	9.5	120
4	60	32	11	350
5	70	37	12	450
6	81	42.8	14	600
8	100	50.8	17	1100
9	108	57	19	1300
10	117.5	63.5	20.5	1500
12	141	76	23	1650

SWIVEL EYE AND JAWS

zoofurni tura. ru

EUROPEAN SWIVEL EYE AND JAW

STAINLESS STEEL AISI316
STAINLESS STEEL AISI304
STEEL ELECTRIC GALVANIZED
DR-Z0017

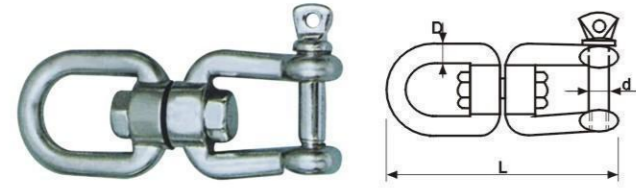

Size mm	D mm	d mm	L mm
5	5	5	59
6	6	6	65
8	8	8	94
10	10	10	118
13	13	13	152
16	16	16	188
19	19	19	229

EUROPEAN SWIVEL EYE AND JAW

STAINLESS STEEL AISI316
STAINLESS STEEL AISI304
STEEL ELECTRIC GALVANIZED
DR-Z0018

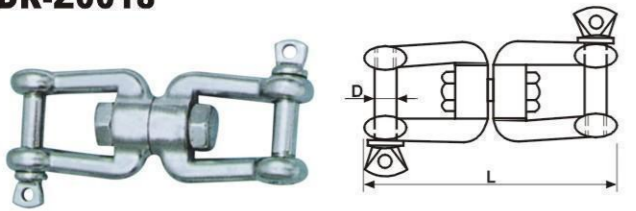

Size mm	D mm	L mm
5	5	59
6	6	66
8	8	94
10	10	118
13	13	152
16	16	188
19	19	229

SWIVEL SNAP SHACKLE ROUND HEAD

STAINLESS STEEL AISI316
STAINLESS STEEL AISI304
STEEL ELECTRIC GALVANIZED
DR-Z0035

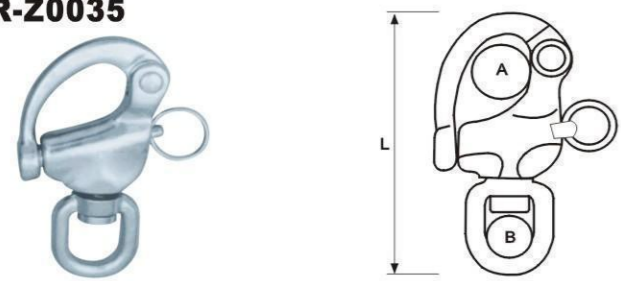

L mm	A mm	B mm
70	12	12
87	16	12
120	22	16

SWIVEL SNAP SHACKLE JAW HEAD

STAINLESS STEEL AISI316
STAINLESS STEEL AISI304
STEEL ELECTRIC GALVANIZED
DR-Z0036

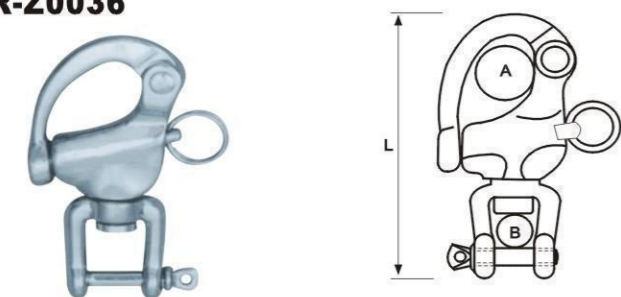

L mm	A mm	B mm
69	12	12
90	16	12
128	22	16

EYE NUT / BOLT / STRAP / PLATE

zoofurni tura. ru

DIN 582 EYE NUT

STAINLESS STEEL AISI316
STAINLESS STEEL AISI304
STEEL ELECTRIC GALVANIZED
DR-Z0029

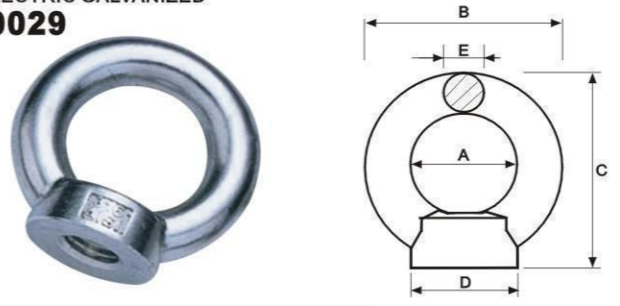

D mm	A mm	B mm	C mm	E mm
6	20	36	36	8
8	20	36	36	8
10	25	45	45	10
12	30	54	53	12
14	30	54	53	12
16	35	63	62	14
18	35	63	62	14
20	40	72	71	16
24	50	90	90	20
30	60	108	109	24
36	70	126	128	18

DIN 580 EYE BOLT

STAINLESS STEEL AISI316
STAINLESS STEEL AISI304
STEEL ELECTRIC GALVANIZED
DR-Z0030

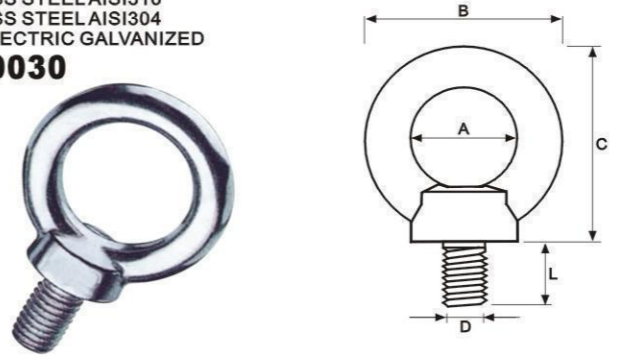

D mm	A mm	B mm	C mm	E mm
6	20	36	36	13
8	20	36	36	13
10	25	45	45	17
12	30	54	53	20
14	30	54	53	20
16	35	63	62	27
18	35	63	62	27
20	40	72	71	30
24	50	90	90	36
30	60	108	109	45
36	70	126	128	54

WIRE EYE STRAP

STAINLESS STEEL AISI316
STAINLESS STEEL AISI304
STEEL ELECTRIC GALVANIZED
DR-Z0031

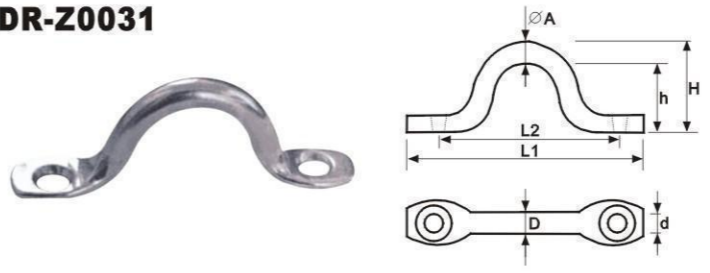

D mm	L1 mm	L2 mm	H mm	h mm	d mm
4	40	32	16	11	3.2
5	50	40	16	13	4.2
6	57	44	22	16	5.2
8	63	47	25	17	5.2

DIAMOND EYE PLATE

STAINLESS STEEL AISI316
STAINLESS STEEL AISI304
STEEL ELECTRIC GALVANIZED
DR-Z0032

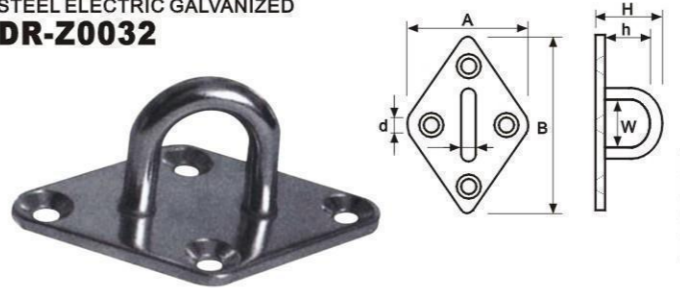

D mm	A mm	B mm	H mm	h mm	W mm	d mm
5	37	59	22	12	11	4.2
6	50	64	26	15	15	4.2
8	60	80	33	20	18	5.2

RINGS

WELDED ROUND RING

STAINLESS STEEL AISI316
STAINLESS STEEL AISI304
STEEL ELECTRIC GALVANIZED

DR-Z0037

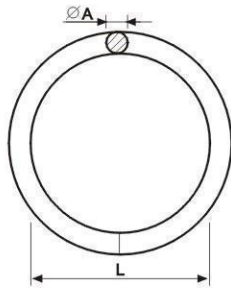

SIZE mm	$\varnothing A$ mm	L mm
3X25	3	25
4X25	4	25
4X30	4	30
4X40	4	30
5X30	5	30
5X40	5	40
5X50	5	50
6X30	6	30

SIZE mm	$\varnothing A$ mm	L mm
6X40	6	40
6X50	6	50
6X60	6	60
7X35	7	35
8X40	8	40
8X50	8	50
10X50	10	50
10X70	10	70

D RING

STAINLESS STEEL AISI316
STAINLESS STEEL AISI304
STEEL ELECTRIC GALVANIZED

DR-Z0038

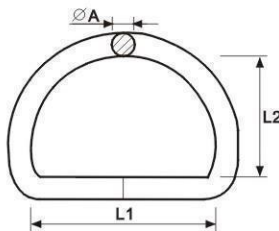

$\varnothing A$ mm	L1 mm	L2 mm
3	25	22
4	25	22
4	30	27
5	30	27
5	40	37

$\varnothing A$ mm	L1 mm	L2 mm
6	40	37
6	50	47
8	40	37
8	50	47
10	50	47

TRIANGLE RING

STAINLESS STEEL AISI316
STAINLESS STEEL AISI304
STEEL ELECTRIC GALVANIZED

DR-Z0039

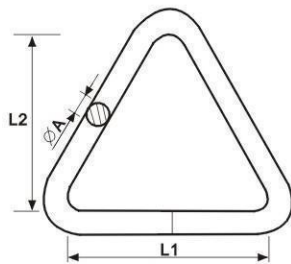

$\varnothing A$ mm	L1 mm	L2 mm
5	30	30
6	50	50
8	50	50

KEY RING

STAINLESS STEEL AISI316
STAINLESS STEEL AISI304
STEEL ELECTRIC GALVANIZED

DR-Z0040

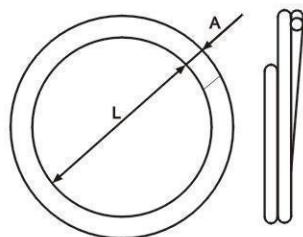

A mm	L mm
1.2	20
1.5	25
2	30
2	38

GENERAL RIGGINGS

"S"HOOK

STAINLESS STEEL AISI316
STAINLESS STEEL AISI304
STEEL ELECTRIC GALVANIZED

DR-Z0041

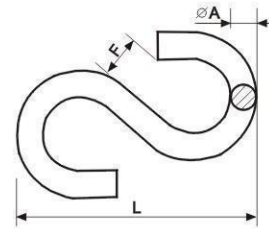

SIZE mm	OA mm	L mm	F mm
3	3	25	3
4	4	35	4.5
5	5	45	6.5
6	6	55	7
7	7	65	8
8	8	75	10
10	10	105	11
12	12	120	13.5

SWIVEL SNAP

ZINC PLATED
NICKEL PLATED
STEEL ELECTRIC GALVANIZED

DR-Z0043



SIZE mm
25
30
40
50
60
70
80
90
100
120

HAIR PIN

ZINC PLATED
NICKEL PLATED
STEEL ELECTRIC GALVANIZED

DR-Z0044

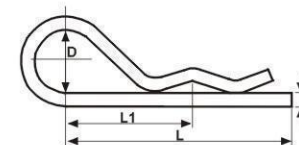

d mm	L mm	L1 mm	D mm
2	50	25	10
3	60	28	18
4	60	30	20
5	85	40	24
6	105	50	30
7	105	50	30
8	110	55	28

HAIR PIN WITH EYELET

ZINC PLATED
NICKEL PLATED
STEEL ELECTRIC GALVANIZED

DR-Z0045

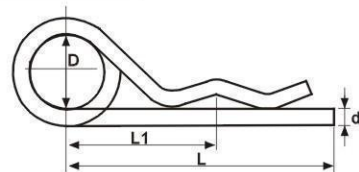
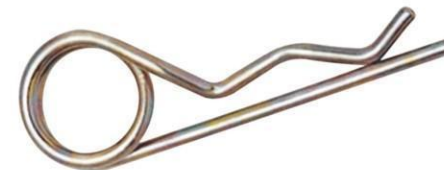

d mm	L mm	L1 mm	D mm
2	50	25	10
3	62	32	16
4	78	44	23
5	92	50	26
6	120	70	30
7	130	72	30
8	130	76	30

GENERAL RIGGINGS

zoofurni tura. ru

LINCH PINS

ZINC PLATED
NICKEL PLATED
STEEL ELECTRIC GALVANIZED

DR-Z0046

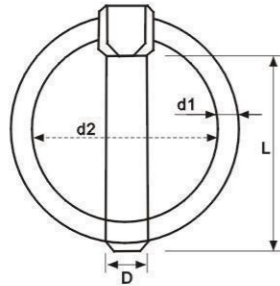

d	L	d1	d2
mm	mm	mm	mm
4.5	30	2	22
5	40	2.5	24
6	45	3	25
7	45	3	38
8	45	3.5	34
9	46	3.5	34
10	46	3.5	34
11	46	3.5	34

SADDLERY BUCKLE

ZINC PLATED
NICKEL PLATED
STEEL ELECTRIC GALVANIZED

DR-Z0047



SIZE	THICKNESS
mm	mm
1 1/2"	5

EYE SLIP HOOKS

ELECTRIC GALVANIZED
320C-CARBON STEEL
320A-ALLOY STEEL
STEEL ELECTRIC GALVANIZED

DR-Z0052

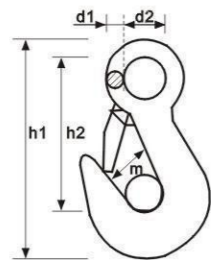

SIZE	d1	d2	h1	h2	m
mm	mm	mm	mm	mm	mm
8	13	25	146	107	32
10	15	28	160	118	36
12	15	29	162	120	36.5
14	17	32	178	130	40
16	18	35	195	140	44.5
18	19	36	199	145	45

SIZE
mm
6X40



RTS

SNAP HOOKS ALUMINUMS

zoofurni tura. ru

ALUMINUM SNAP HOOK D TYPE

DR-Z0048

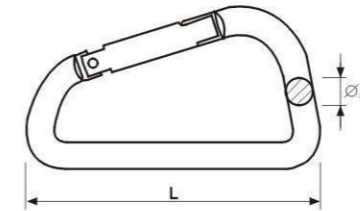

SIZE	∅A	L
mm	mm	mm
5X50	5	50
6X60	6	60
7X70	7	70
8X80	8	80
10X100	10	100

ALUMINUM SNAP HOOK CARBINE TYPE

DR-Z0049

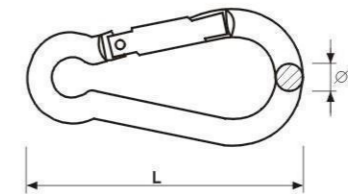

SIZE	∅A	L
mm	mm	mm
5X50	5	50
6X60	6	60
7X70	7	70
8X80	8	80
10X100	10	100

ALUMINUM SNAP HOOK EGG TYPE

DR-Z0050

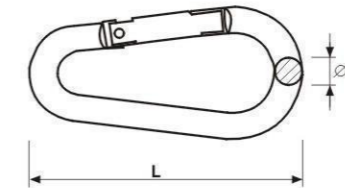

SIZE	∅A	L
mm	mm	mm
5X50	5	50
6X60	6	60
7X70	7	70
8X80	8	80
10X100	10	100

ALUMINUM SNAP HOOK D TYPE WITH PIN

DR-Z0051

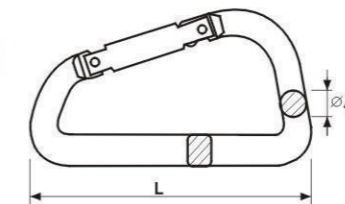

SIZE	∅A	L
mm	mm	mm
5X50	5	50
6X60	6	60
7X70	7	70
8X80	8	80
10X100	10	100